













Appearance							
Mounting	Shielded			Unshielded			
Housing size	M12	M18	M30	M12	M18	M30	
Sensing distance	1~3mm adjustable	2~8mm adjustable	2~20mm adjustable	1~6mm adjustable	2~15mm adjustable	2~30mm adjustable	
Housing material	PBT						
Operating voltage	10~30V DC(Ripple < 10%)						
Voltage drop	< 2V						
Load Current, Max	150mA	300mA		150mA	300mA		
Current consumption	< 10mA						
Leakage current	< 0.01mA						
Switch frequency	100Hz						
Repeat accuracy	< 5% (Sr)						
Hysteresis	< 15% (Sr)						
Sensing surface material	PBT						
Operating Temperature	-25°C~+75°C						
Protective circuit	Short circuit						
Degree of protection	IP67						
Model No.	NPN Normally open	CKF12-03 	CKF18-08 	CKF30-20 	CKN12-06 	CKN18-15 	CKN30-30 
Others	 :NPN Normally open  :NPN Normally closed  :PNP Normally open  :PNP Normally closed						

- Fiber Optic
- Slot Sensors
- Photoelectric
- Laser
- Proximity**
- Displacement
- Magnetic
- Contact
- Area
- Ultrasonic
- Vision
- Vibration
- Temperature
- Annexes

Dimensions-Plastic Shells (Unit:mm)

M12

CKF12-03

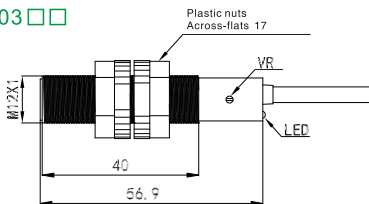

CKN12-06

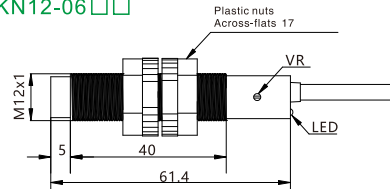

M18

CKF18-08

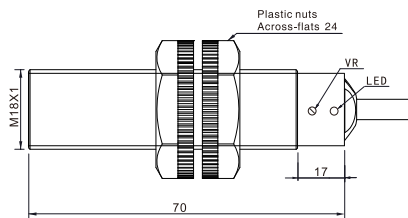

CKN18-15

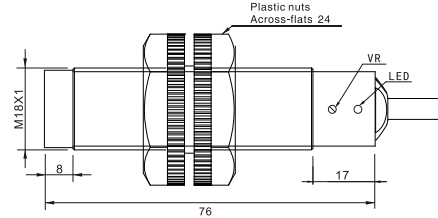

M30

CKF30-20

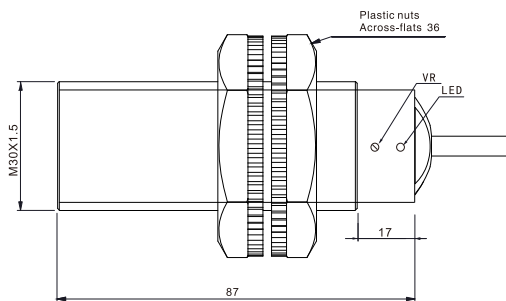

CKN30-30

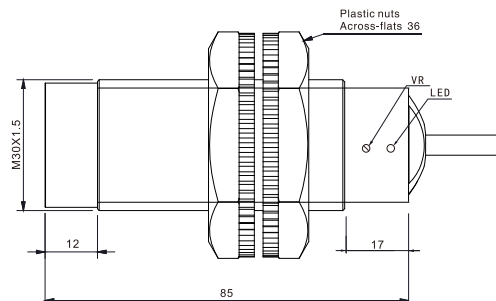

Guidance

Inductive sensors

- Standard distance
- Extended distance
- Long distance
- Square
- Mini square
- Mini-cylindrical
- Short-body
- Ring-type
- Metal face
- Temperature
- Analog output
- DC 2 wires
- IP69K high protection

Capacitive sensors

- Cylindrical**
- Correction resistanc type
- Flat type
- Level detection